

Dear Customer,

we offer you the opportunity to let our fabric also be processed.

For this we only need some information from you.

On the following pages, you have several options for processing.

We will gladly make you a no obligation, free for you, offer to the sewing and the fabric that is needed.

## 1. Side Scarfs:

Side scarfs can serve not only for decorative purposes, but can also be a visual barrier.

At the same time it gives a nice overall picture if you hang matching net curtains left and right

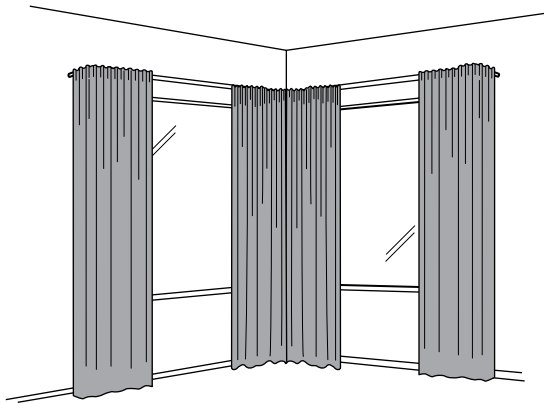

next to the decorative curtains.

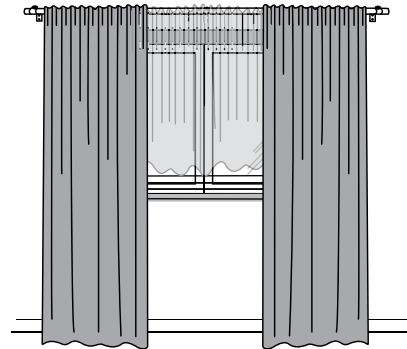

## 2. Panel curtains

Panel curtains are an excellent view-protection for your windows.

These are also often used as a room divider.

With us you have the option to receive curtains trimmed, sutured and provided with a loop tape. If you do not have devices (rail and panels) you can get the curtains in one complete package from us. There, the complete technology for assembly is included.

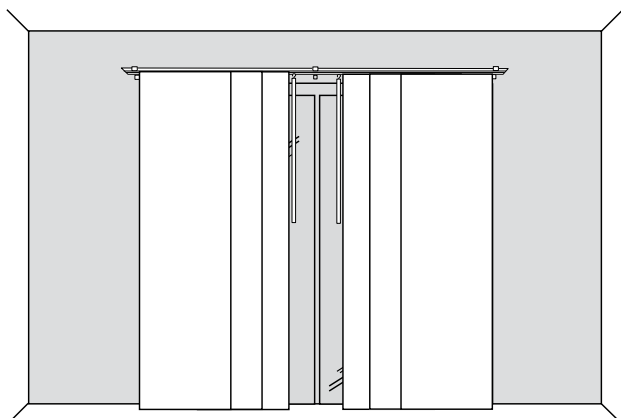

### Do not hesitate to contact us!

Speak directly with our Interior Master Iris Ewering or send an e-mail:

☎ +49 (0) 1635-948719

✉ raumausstattung@ewering.de

You have different options to let yourself sew one or multiple page scarves from your favorite fabric. Please check which option you imagine for your window.

Select the type of page scarf in 1.1 and in 1.2 the desired scarf hanger:

1.1

**Bodentief:**

1 Side scarf

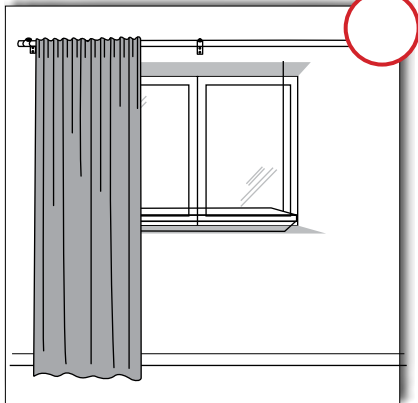

Item no.: \_\_\_\_\_

2 Side scarfs

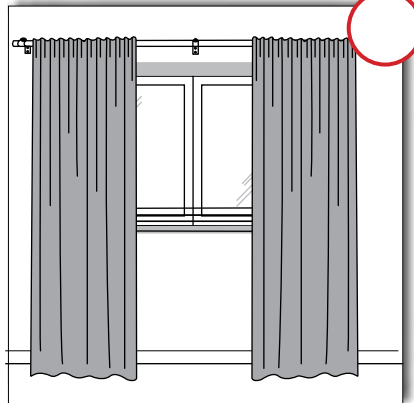

Item no.: (right) \_\_\_\_\_

Item no.: (left) \_\_\_\_\_

2 Side scarfs + Store

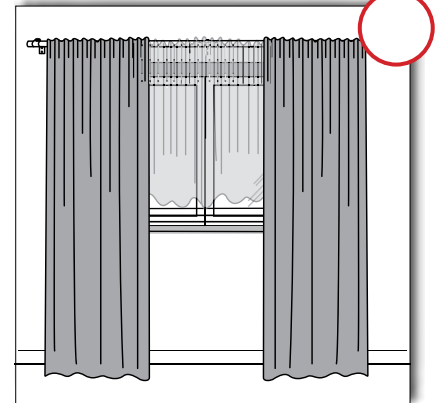

Item no.: (right) \_\_\_\_\_

Item no. (left) \_\_\_\_\_

Item no.: (centered) \_\_\_\_\_

**or this variant**

**Window high:**

1 Side scarf

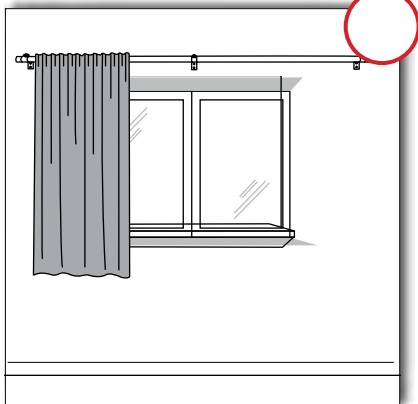

Item no.: \_\_\_\_\_

2 Side scarfs

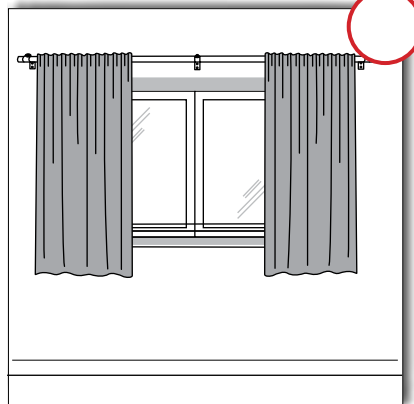

Item no.: (right) \_\_\_\_\_

Item no.: (left) \_\_\_\_\_

2 Side scarfs + Store

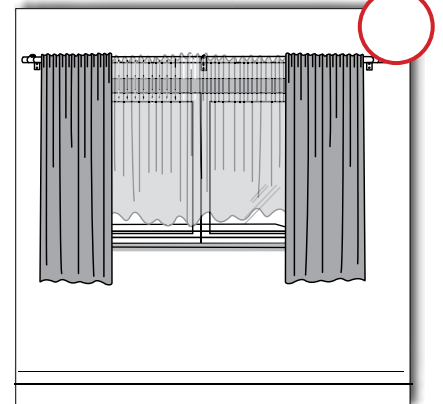

Item no.: (right) \_\_\_\_\_

Item no. (left) \_\_\_\_\_

Item no.: (centered) \_\_\_\_\_

The production of your curtain can almost begin, we only need the desired dimensions and the desired scarf hanger:

Please enter here the exact dimensions of the composition of your window, so we can plan for you. Please notice that we don't sew a fabric without having discussed the cost with you in advance.

1.2

## Your dimensions (normal window):

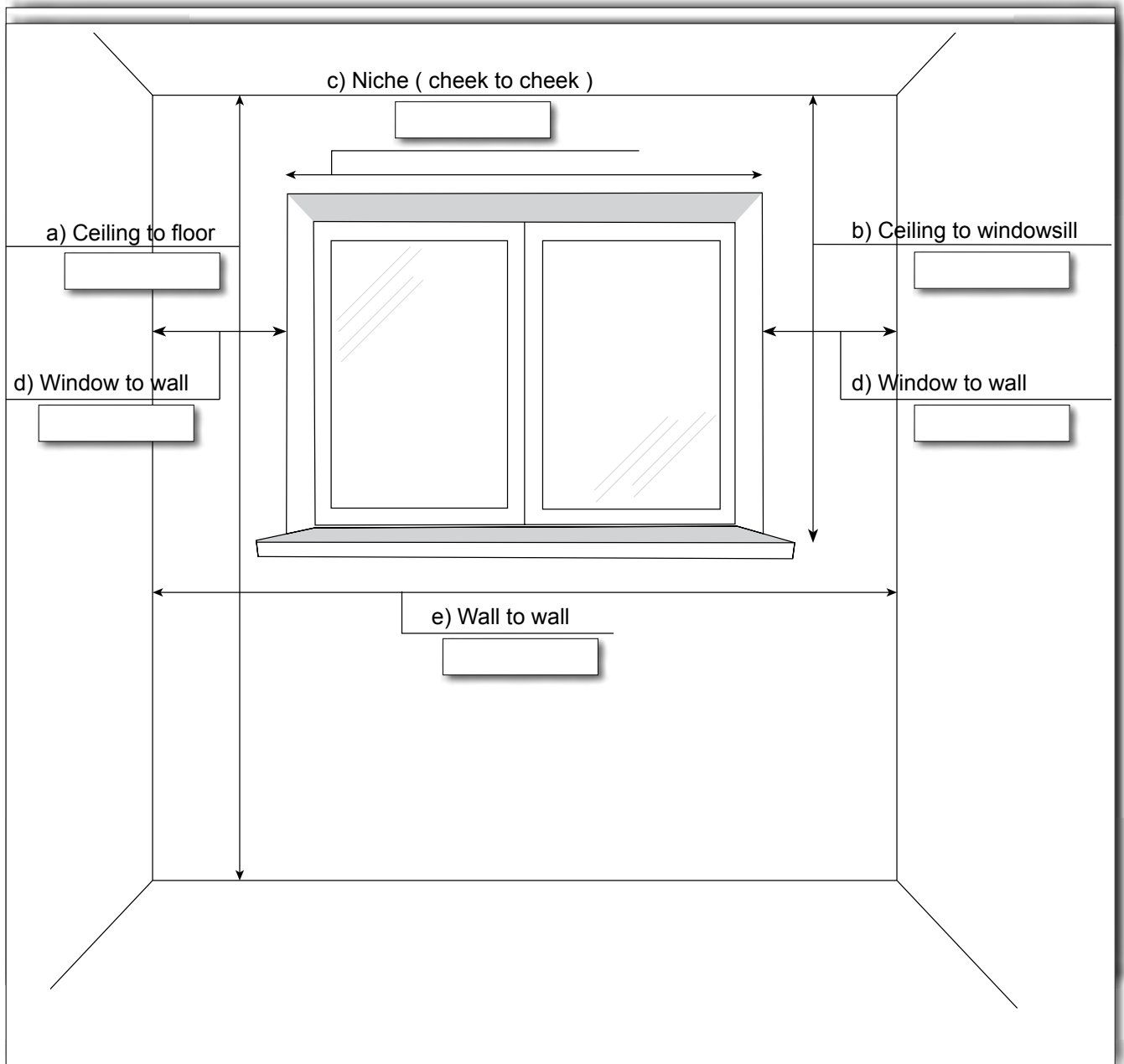

The production of your curtain can almost begin, we only need the desired dimensions and the desired scarf hanger:

Please enter here the exact dimensions of the composition of your window, so we can plan for you.

2.3

**Your dimensions:**

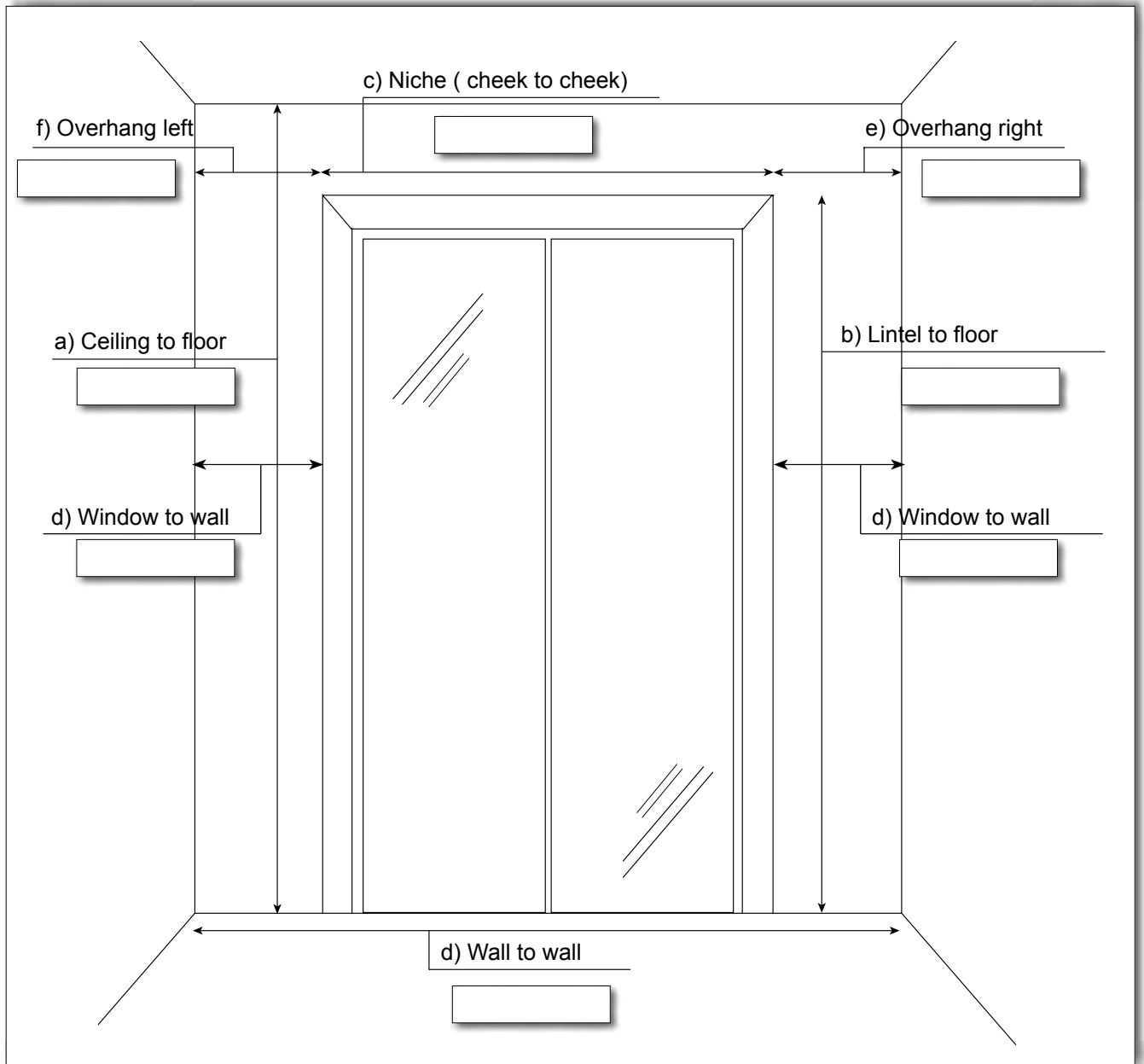

Please enter in the provided fields the corresponding dimensions in cm. With your dimensions we can create an exact and individual quotation.

Please enter the appropriate scarf hanger here.

If you have a curtain rod hanging to your window, eyelets or loops would be perfect for your scarves.

Do you have a rail?- Then you can get your scarves sewed with a curling ribbon.

1.3

## The suspension

Eyelets

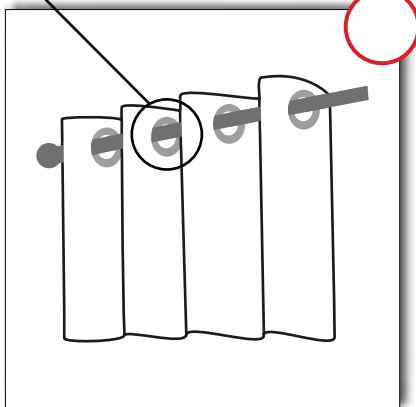

Curling ribbon

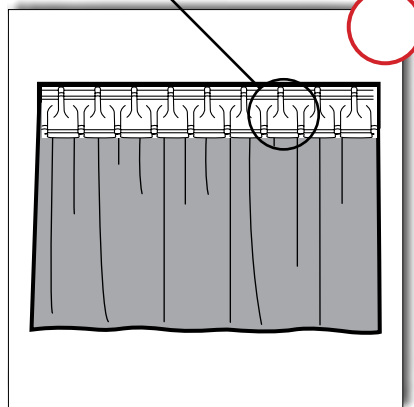

Loops

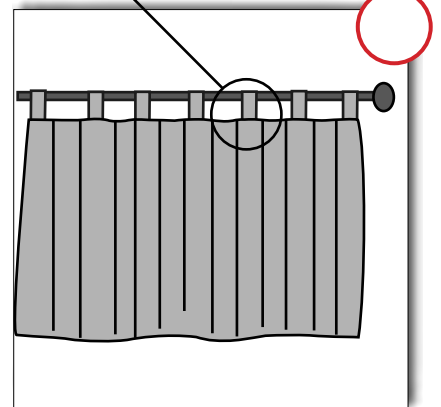

1.4

## Your contact:

Last Name:

First Name:

Street, No.:

Postcode:

City:

Country:

Phone:

E-Mail:

## Here everything compactly summarized for you

If you are interested in the further processing of a fabric to a page scarf or panel curtain, simply fill out the form completely.

With this information, we provide you a completely free, not binding offer.

You are welcome to send us the completed form by e-mail or by fax.

If we had any questions, we would contact you by phone or e-mail.

For questions you can reach us by phone, by email or locally in Reken.

**Ewering Raumdesign**  
**Schulstraße 3**  
**48734 Reken**

**Phone:** +49 (0)2864/9487-90

**Fax.:** +49 (0)2864/9487-99

**E-Mail:** shop@ewering.de

If you have technical questions, you can contact our Interior Master Iris Ewering directly:

**Mobile** +49 (0) 1635-948719

## Our opening hours:

MO-FR: 08:30 - 12:30 Uhr

14:00 - 18:30 Uhr

SA: 08:30 - 13:00 Uhr